

承 认 书

SPECIFICATION

蓝 晋 光 电	客 户 资 料
产品名称: SMD LED	客 户:
产品型号:B3806SW9CWY	机 型:
规格描述: 020白光	日 期: 2016年9月28日

设 计:	日 期:
审 核:	
批 准:	承 办:

客 户 确 认	
签 名:	日 期:
结 论:	

■ Features

- P-LCC-2 package White package.
- White package.
- Optical indicator.
- Colorless clear window.
- Pb free.
- The product itself will remain within RoHs compliant version

■ Descriptions

- The 020 series is available in soft orange,green,blue and yellow .
 Due to the package design, the LED has wideviewing angle and optimized light coupling by inter reflector.The low current requirement makes this device ideal for portable equipment or any other application where power is at a premium.

■ Applications

- Telecommunication,indicator and backlighting in telephone and fax.
- Flat backlight for LCD's,switches and symbols.
- Light pipe application.
- General use.

■ Device Selection Guide

Chip			Lens Color
Type	Material	Emitted Color	
B3806SW9CWY	AlGaInP	WHITE	Yellow diffused

Part numbering (B3806SW9CWY)
B-- First letter of "BOSMFC"
38-- length of side view 020 LED
06-- width of side view 020 LED
SW-- supper white
09-- height of side view 020 LED
C-- side view
W-- LED no notch
Y-- Yellow diffused lens

■ Package Outline Dimensions

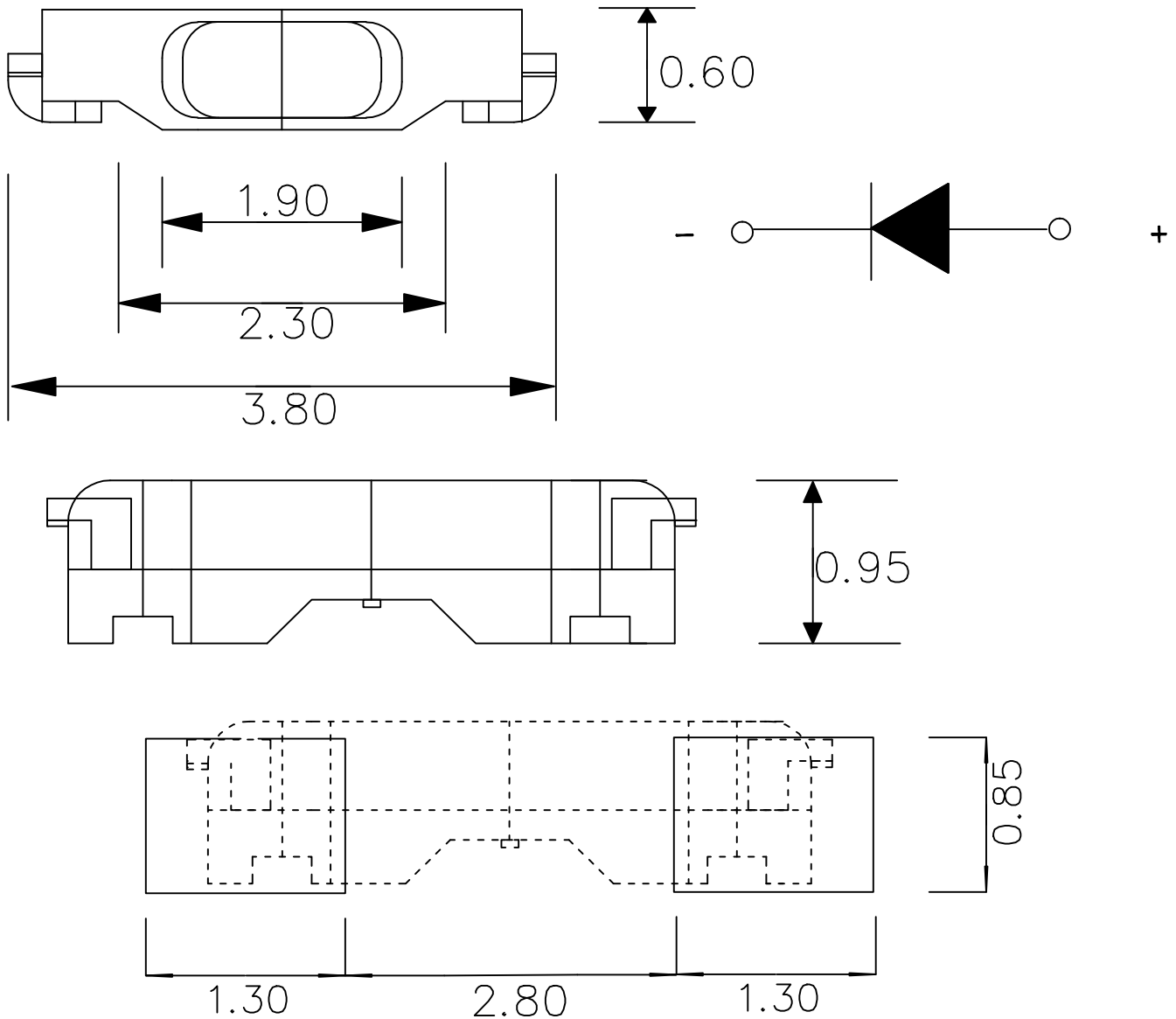

Note: The tolerances unless mentioned is $\pm 0.1\text{mm}$; Unit = mm

■ Absolute Maximum Ratings($t_a=25^{\circ}\text{C}$)

ITEMS	SYMBOL	Rating		UNIT
Reverse Voltage	VR	5		V
Forward Current	If	W	25	MA
Operation Temperature	Topt	-40~ +85		$^{\circ}\text{C}$
Storage Temperature	Tstg	-40~ +100		$^{\circ}\text{C}$
Electrostatic Discharge(HBM)	ESD	W	2000	V
Power Dissipation	Pt	W	100	MW
Peak Forward Current(Duty 1/10 @1KHZ)	IFP	W	60	MA
Soldering Temperature	Tsol	Reflow Soldering : 220 $^{\circ}\text{C}$ for 10 sec		

■ Absolute Maximum Ratings($t_a=25^{\circ}\text{C}$)

Parameter	Symbol		Min.	Typ.	Max.	Unit	Condition
Luminous Intensity	I_v	W	2200	---	3200	mcd	IF=20mA
Peak Wavelength	Tc	W	---	6500	---	K	IF=20mA
Color rendering index		W	6000	----	7000	K	IF=20mA
Spectrum Radiation Bandwidth	$\Delta \lambda$	W	—	20	—	nm	IF=20mA
Forward Voltage	V_F	W	2.8	---	3.4	v	IF=20mA
Viewing Angle	2 ϕ 1/2		—	110	—	deg	IF=20mA
Reverse Current	I_R	W	—	—	1	uA	VR=5v

■ *For each die

Notes:

- 1.Tolerance of Luminous Intensity $\pm 3\%$
- 2.Tolerance of Dominant Wavelength $\pm 1\text{nm}$
- 3.Tolerance of Forward Voltage $\pm 0.03\text{V}$

■ Typical Electrical–Optical Characteristics Curves(W)

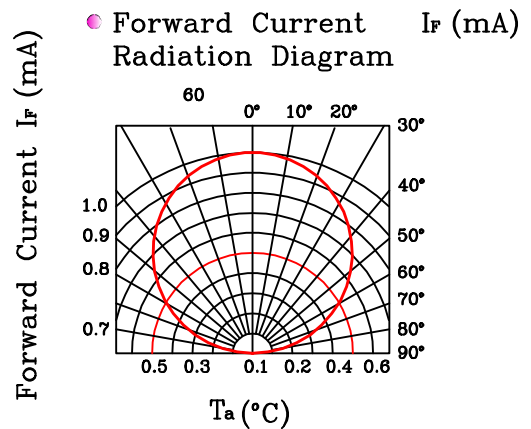
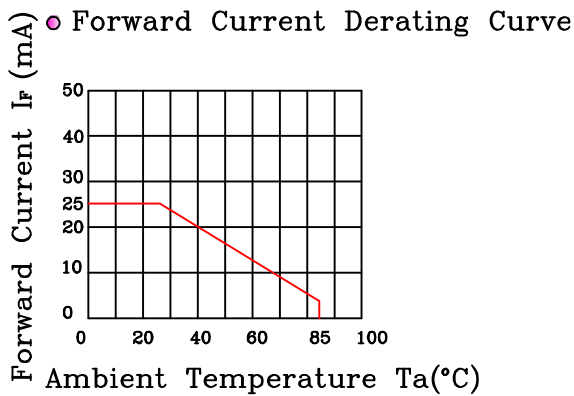
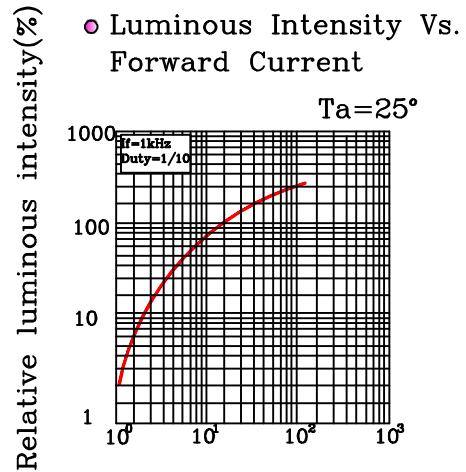
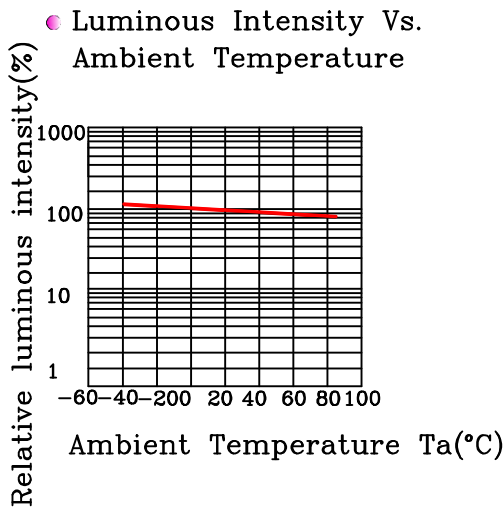
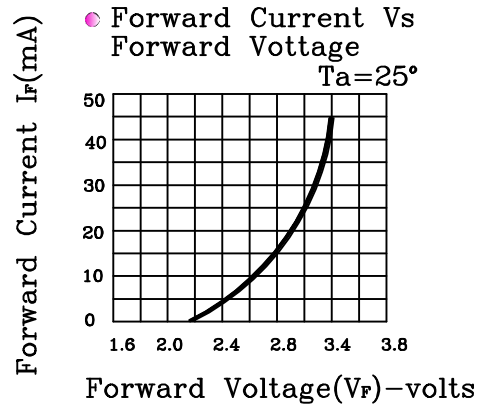
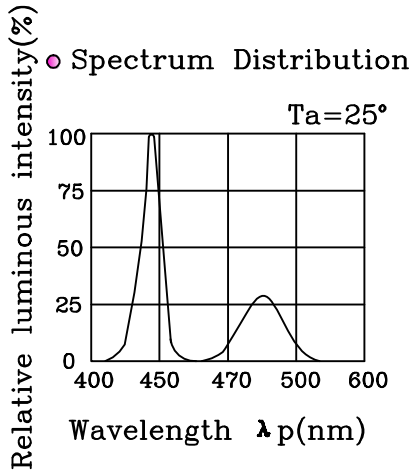

The reliability of products shall be satisfied with items listed below.
 Confidence level:90%

LTPD:10%

NO	Items	Test Condition	Test Hours/Cycles	Sample Size	Ac/Re
1	Reflow Soldering	Temp: 220±5°C	6min	22 PCS	0/1
2	Temperature Cycle	H:+100°C15min ∫ 5min L:-40°C15min	300 Cycles	22 PCS	0/1
3	Thermal Shock	H:+100°C 5min ∫ 10sec L:-10°C 5min	300 Cycles	22 PCS	0/1
4	High Temperature Storage	Temp :100°C	1000 Hrs	22 PCS	0/1
5	LowTemperature Storage	Temp :-40°C	1000 Hrs	22 PCS	0/1
6	DC Operating Life	IF=20mA	1000 Hrs	22 PCS	0/1
7	High Temperature High Humidity	85°C/85%RH	1000 Hrs	22 PCS	0/1

■ Guideline for Soldering(1)

○ Reflow Soldering

Use the conditions shown in the under Figure of Pb-Free Reflow Soldering.

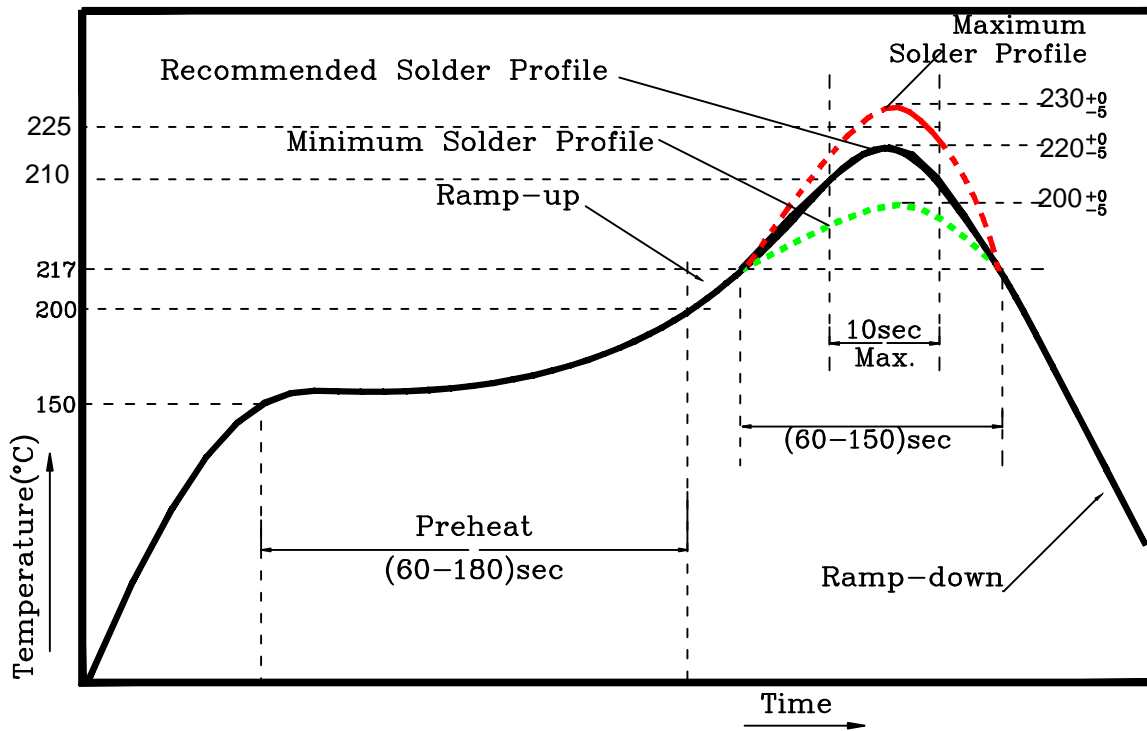

- Reflow soldering should not be done more than two times .
- Stress on the LEDs should be avoided during heating in soldering process
- After soldering, do not deal with the product before its temperature drop down to room temperature.

■Precautions(1)

● Storage

Moisture proof and anti- electrostatic package with moisture absorbent material is used , to keep moisture to a minimum

Before opening the package,the product should be kept at 30°C or less and humidity less than 60%Rh,and be used within a year.

Afer opening the package,the product should be stoted at 30 or less and humidity less than 10%RH,and be soldered within 24 hours.It is recommended that the product be operated at the workshop condition of 30°C or less and humidity less than 60%RH

If the moisture absorbent material has fade away or the LEDS have exceeded the storage time,baking treatment.should be performed based on the following condition:(60±5C) for 12 hours.

● Static Eleetricity

Static electricity or surge voltage damages the LEDs . Damaged LEDs will show some unusual characteristics such as the forward voltage becomes lower, or the LEDs do not light at the low current . even not lihgt

All devices, equipment and machinery must be properly grounded. At the same time, it is recommended that wrist bands or anti-electrostatic gloves,anti-electrostatic containers be used when dealing with the LEDs.

■ Precautions(2)

○ Design Consideration

In designing a circuit, the current through each LED must not exceed the absolute maximum rating specified for each LED . In the meanwhile,resistors for protection should be applied,otherwise slight voltage shift will cause big current change,burn out may happen.

It is recommended to use Circuit A which regulates the current flowing through each LED rather than Circuit B. in forward V oltage (Vf) of the LEDs.In the worst case ,some LED may be subjected to stresses in excess of the Absolute Maximum Rating

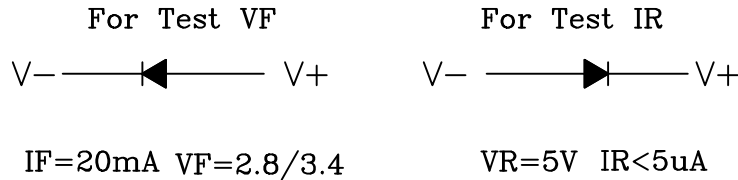

○ Thermal Design is paramount importance because heat generation may result in the Characteristics decline, such as brightness decreased, Colr changed and so on.Please consider the htat generation of the LEDs when making the system design.